

STABILA®

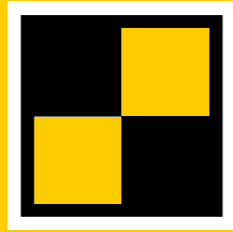

How true pro's measure

TECH 500 DP

User manual



Contents

Section	Page
• 1 Intended use	3
• 2 Safety information	3
• 3. Components of the unit	4
• 4. Display elements	5
• 5. Commissioning	6
• 5.1 Inserting batteries/battery replacement	6
• 5.2 Switching the unit on	6
• 6. Functions	7
• 6.1 Visual guidance	7
• 6.2 Acoustic guidance	8
• 6.3 Automatic display inversion	8
• 6.4 Setting the MODE unit of measurement	9
• 6.5 Locking the measurement with HOLD	9
• 6.6 Freely selectable zero position REF	10
• 6.7 Lighting	11
• 6.8 Key lock	11
• 6.9 Automatic switch-off time: Auto OFF	11
• 7. Checking the measuring tool	12
• 7.1 Accuracy check	12
• 7.2 Calibration	13
• 7.3 Adjusting the sensor	14
• 7.4 Error messages	17
• 8. Technical data	18

1. Intended use

Congratulations on the purchase of your STABILA measuring tool. The STABILA TECH 500 DP is a digital measuring tool for measuring inclinations.



If you still have questions after reading through the operating instructions, you can obtain advice by telephone:

+49 63 46 3 09 0

Equipment and functions:

- Tough, independent digital protractor for quick and accurate measurements
- Integrated rare-earth magnet for attachment
- Integrated V-groove for aligning on round surfaces
- Integrated T-groove for attachment
- Batteries for operation
- Carrying case

2. Safety information

- Read the safety instructions and operating instructions through carefully.
- Keep these operating instructions in a safe place and include them when passing the measuring tool on to another person.
- Do not dispose of the unit with domestic waste. Please observe the relevant national laws.
- Allow only qualified persons to operate the unit.
- Keep the unit out of the reach of children.
- Do not use in explosive or corrosive environments.
- Do not immerse the unit in water.
- If the unit is dropped or subjected to strong vibrations it may malfunction.
- Check that the unit is functioning correctly and accurately at regular intervals, particularly if it has been exposed to heavy vibrations.
- Do not open the unit.

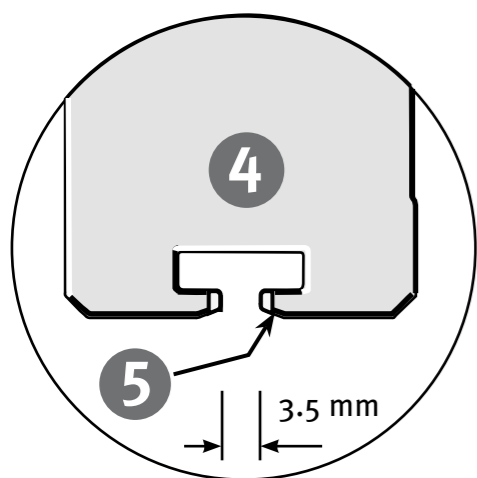
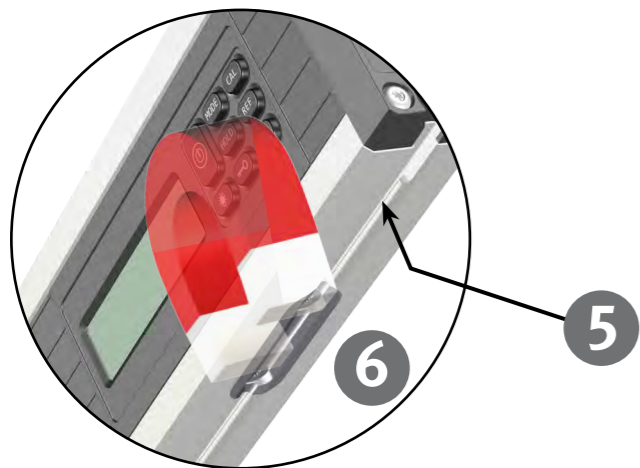
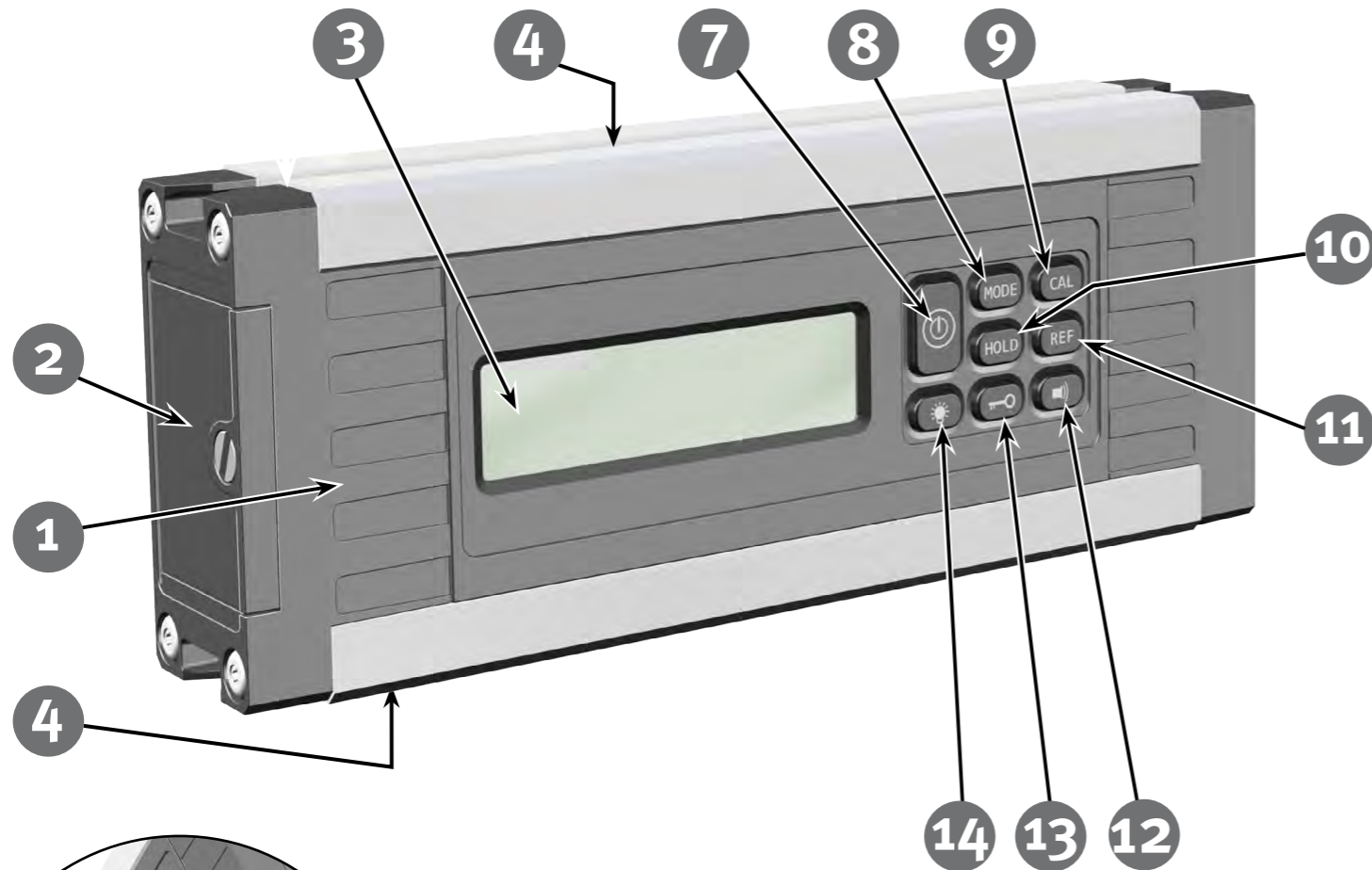

3. Components of the unit

- (1) TECH 500 DP
(dust-proof and waterproof in accordance with IP 65)
- (2) Battery compartment lid
- (3) Display
- (4) T-groove profile for securing with M4 groove stones, e.g. Bosch Rexroth® or square nut in accordance with DIN 557
- (5) V-shape for aligning on round surfaces
- (6) Rare-earth magnet

Buttons:



- (7) On/Off



- (8) Units of measurement: °, %, mm/m, in/ft



- (9) Calibration and sensor adjustment



- (10) HOLD – locking measurements



- (11) Reference – freely selectable zero position



- (12) Acoustic guidance



- (13) Key lock



- (14) Display lighting

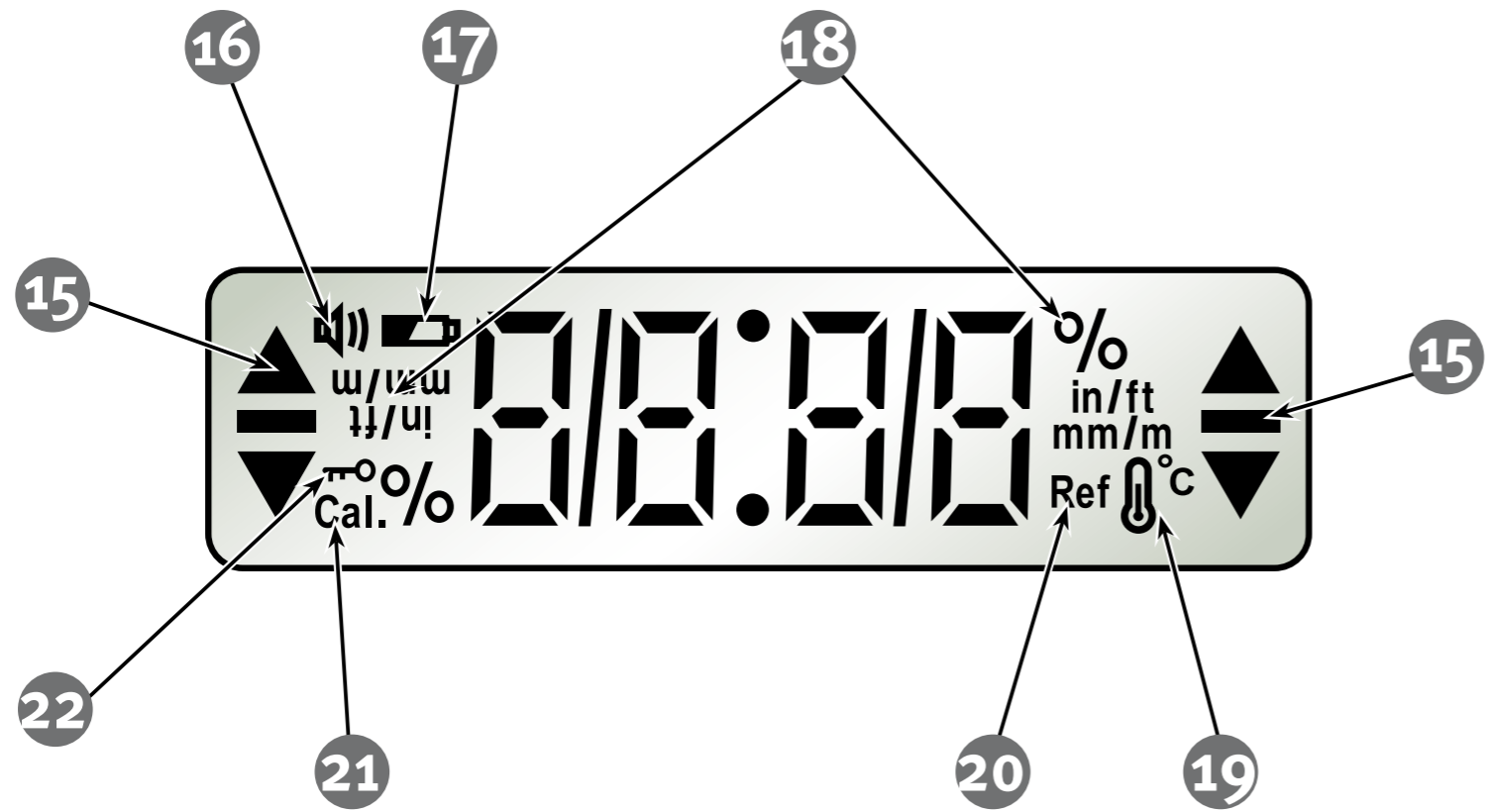

4. Display elements

- (15) Elements for visual guidance
- (16) Acoustic guidance: activated
- (17) See chapter 5.1
- (18) Units of measurement: °, %, mm/m, in/ft
- (19) See chapter 7.4
- (20) Reference: activated
- (21) See chapter 7.4
- (22) Key lock: activated

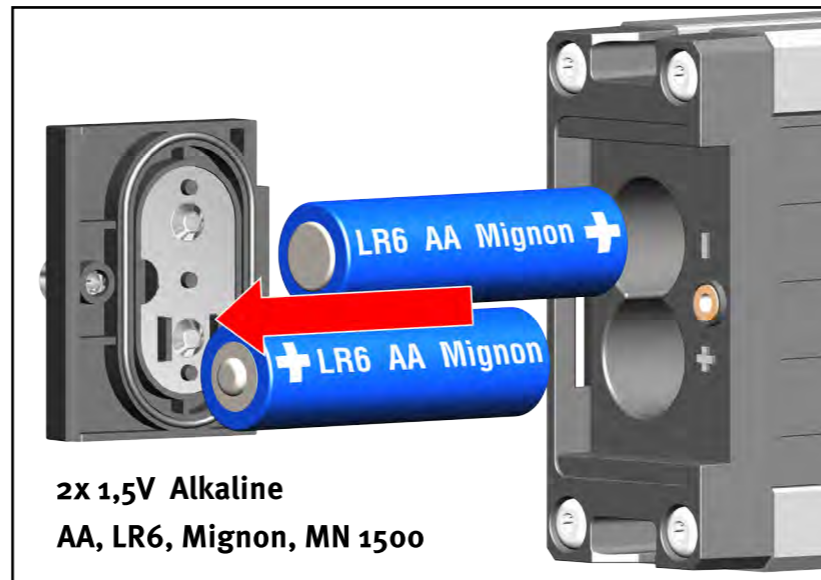
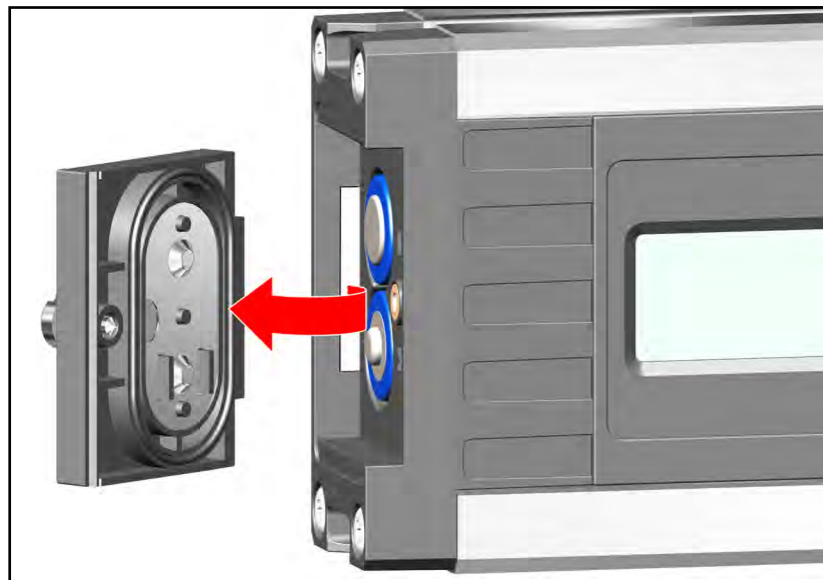

5. Commissioning

5.1 Inserting batteries/battery replacement

Unscrew battery compartment lid, insert new batteries into battery compartment according to symbol. Suitable rechargeable batteries can also be used.



LCD indicator:
Battery low – insert new batteries



Dispose of used batteries at suitable collection points – not with household waste. Do not leave in unit!

If you do not intend to use the unit for an extended period, remove the batteries.



Test

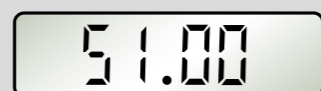

Software Version



Auto OFF



= OK ✓

5.2 Switching the unit on

After switching on with the "ON/OFF" button, an automatic test is carried out. All the display's segments are shown.

After the end of the test, the version number S x.xx of the software is briefly displayed and the automatic switch-off time (Auto OFF) is shown.

An acoustic signal indicates that the unit is ready for operation.

The display shows the angle measured in the set unit of measurement.

6. Functions

6.1 Visual guidance

In the range of $\pm 15^\circ$ to the horizontal (0°) or to the vertical (90°), arrows show which way to turn the digital protractor to reach 0° or 90° .

The 2 "centre display" bars indicate the precise position at which 0° or 90° is reached.

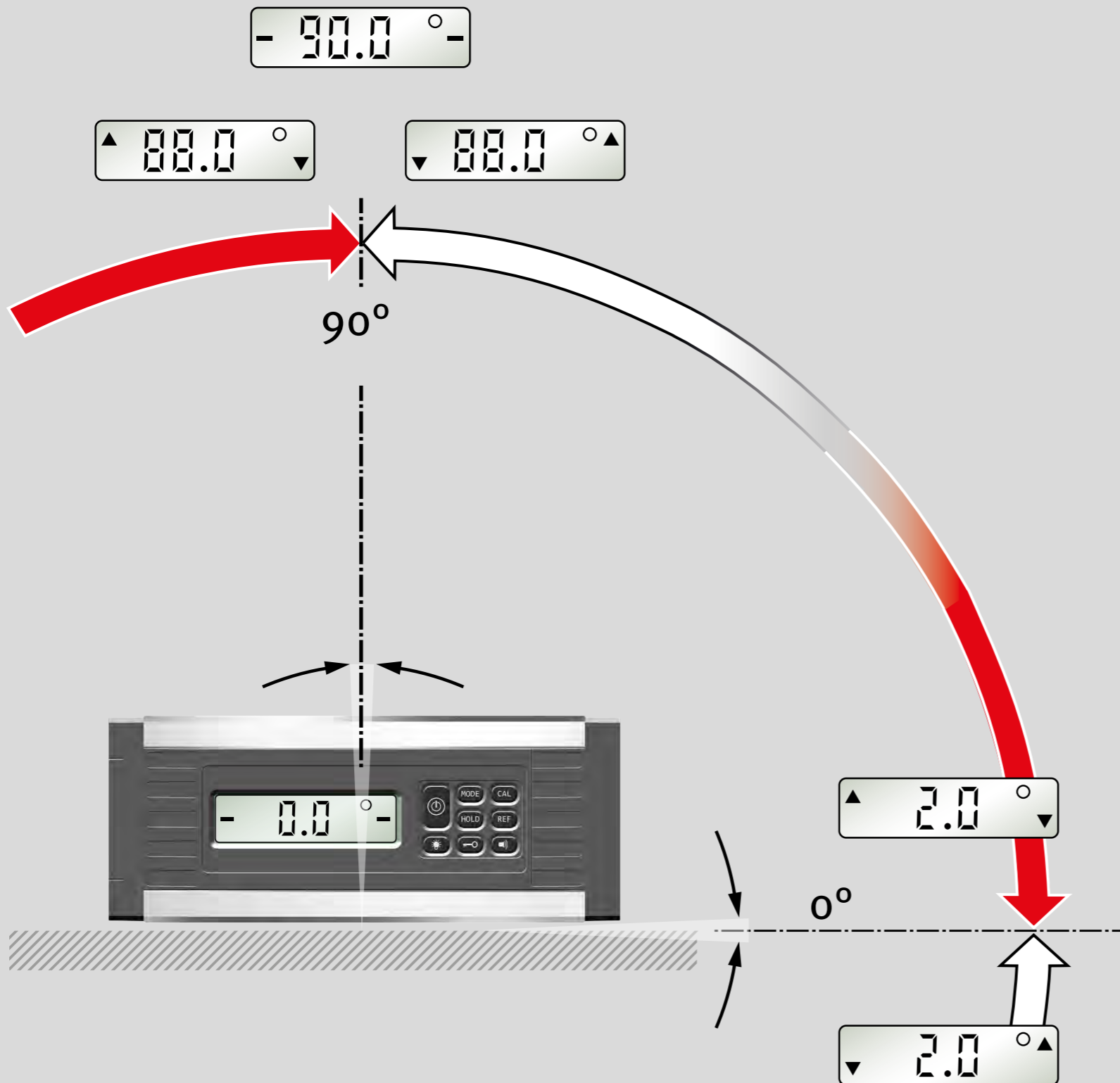

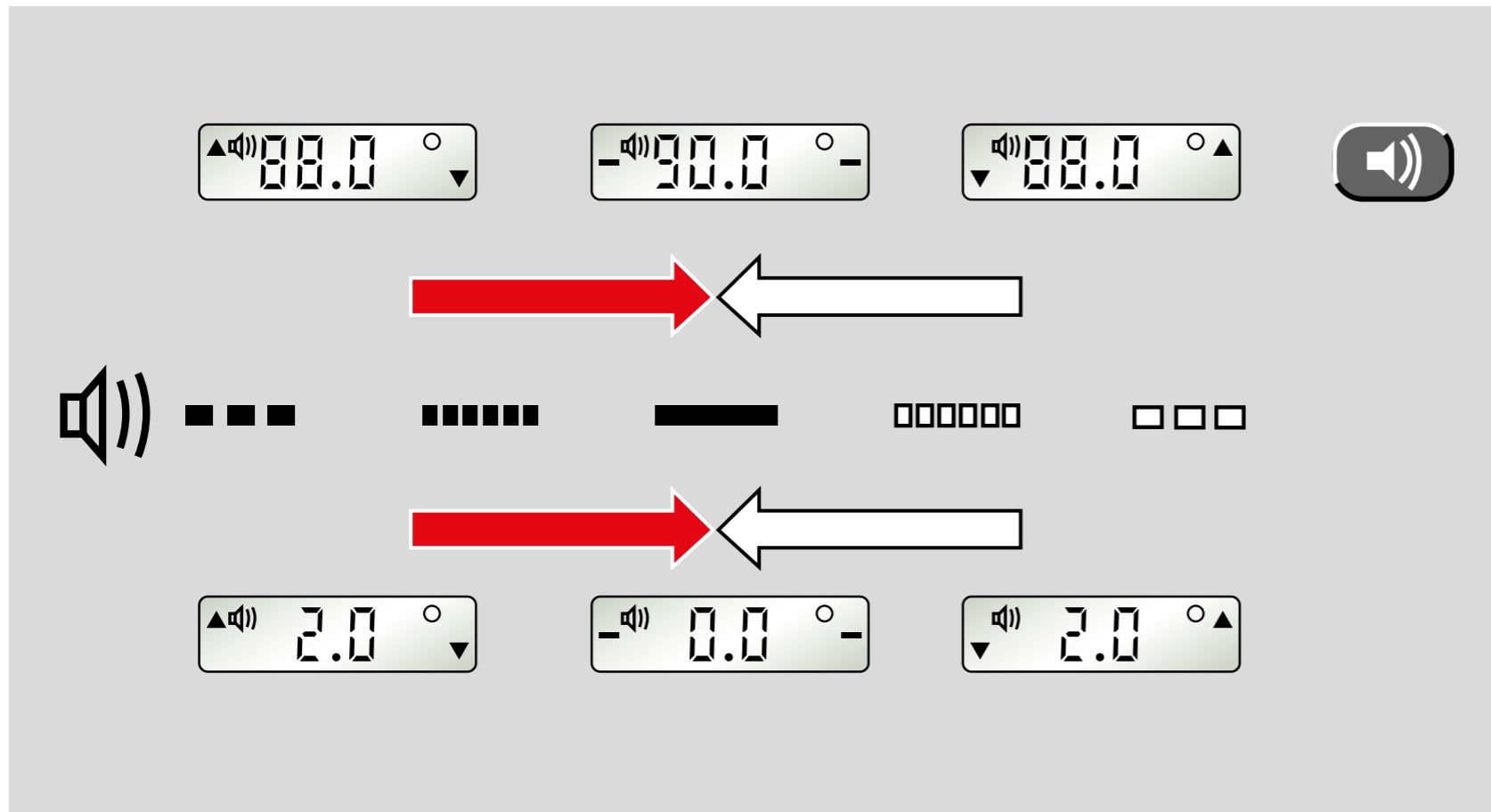

6.2 Acoustic guidance

The acoustic guidance is activated/deactivated using the "Loudspeaker" button. The tone sequence speeds up as the 0° or 90° position is approached in a range of $\pm 2^\circ$. A change in the pitch indicates that these positions have been exceeded.

A continuous tone confirms the precise point at which 0° or 90° is reached.

6.3 Automatic display inversion

The display is inverted for overhead measurements so that they are always easy to read.



MODE

The diagram illustrates the effect of pressing the **MODE** button. It shows a sequence of six display states:

- 10.01° (Resolution: 0,01°)
- 10.0° (Resolution: 0,1°)
- 17.7 %
- 177 mm/m
- 2.12 in/ft
- 2 1/8 in/ft

A **MODE** button is shown to the right of the first two states.

6.4 Setting the MODE unit of measurement

The unit of measurement is set by pressing the "MODE" button several times.

- ° Fine: Display in 0.01° steps
- ° Rough: Display in 0.1° steps
- %: Display in 0.1 % steps
- mm/m: Display in 1 mm/m steps
- in/ft decimal: Display in 0.01 in/ft steps
- in/ft fraction: Display in 1/8 in/ft steps

The set unit of measurement is retained after the unit is switched off.



HOLD

6.5 Locking the measurement with HOLD

The current measurement can be locked by pressing the "HOLD" button. The visual guidance indicator flashes. The measurement is displayed continuously. The locked measurement is deleted by pressing the "HOLD" button again or switching the unit off.



20°

A

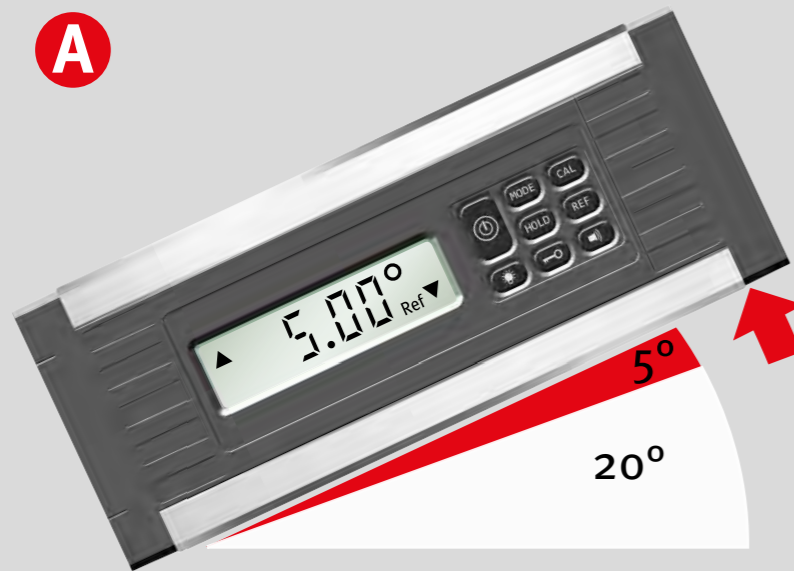

20°

B



25°



REFERENCE

20°

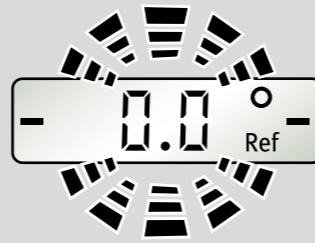

REF

≙ 20°

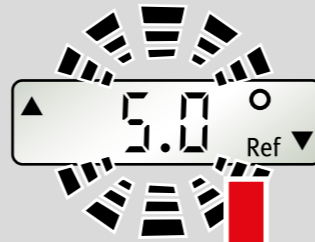

≙ 25°

REF

+ 5°

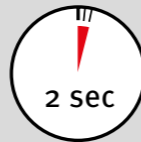
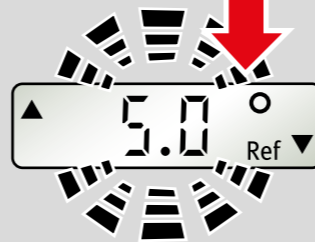

REF

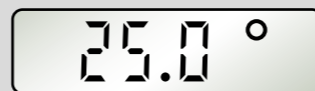

RESET
REFERENCE

6.6 Freely selectable zero position REF

The "REF" button can be used to select any set angle as 0° reference. The angle details now displayed relate to this reference angle. The displayed value flashes with this setting.

A:

The reference angle value is displayed for 2 seconds by briefly pressing the "REF" button.

B:

The reference angle is deleted by:

- pressing and holding (≥ 3 sec) the "REF" button. The activated button lock must be released before deleting the angle.
- Switching off
- The automatic switch-off function

The zero position then refers back to the original setting.



The alignment selected for the digital protractor must not be changed during the reference function, as this could lead to a display error.

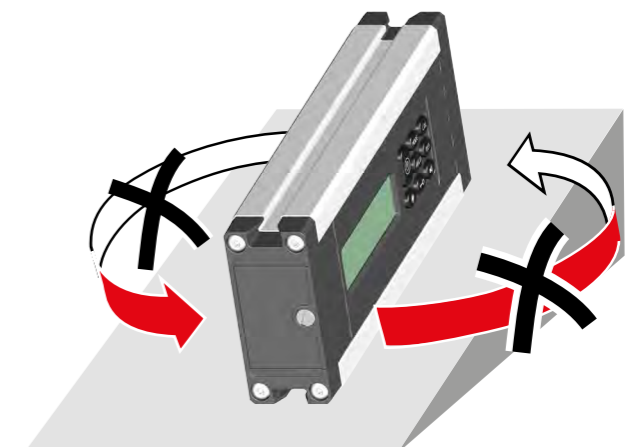

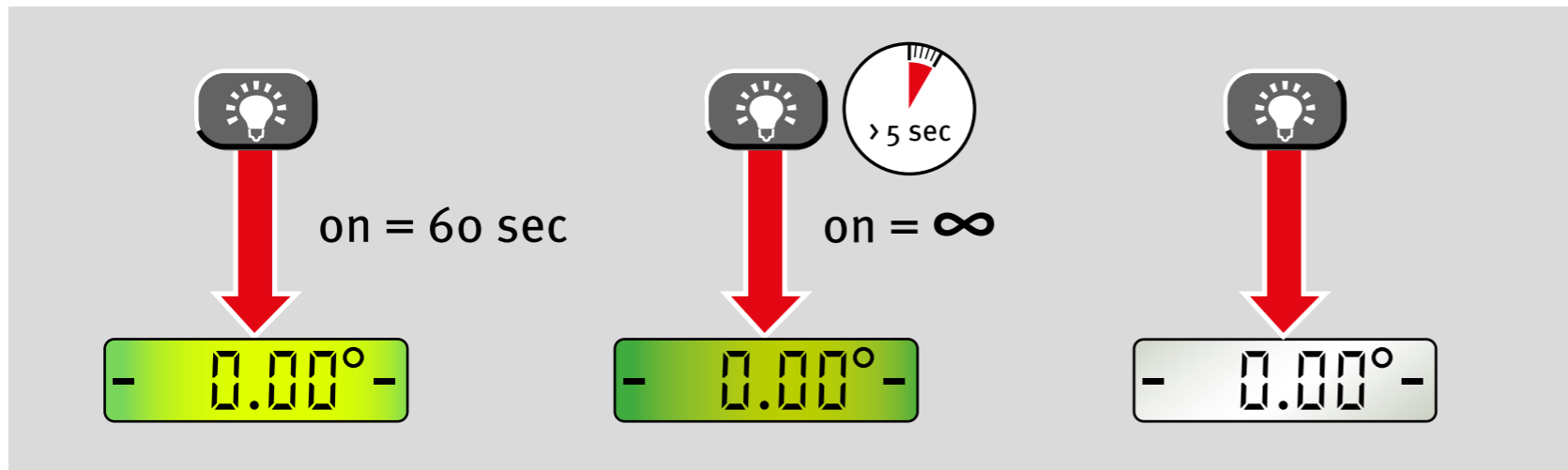

6.7 Lighting

Briefly pressing the "Lighting" button switches the display lighting on for approx. 60 seconds.

Pressing and holding (≥ 5 sec) the "Lighting" button makes the lighting darker and switches it on permanently.

The lighting is switched off by pressing the "Lighting" button again, or by switching off the unit.



6.8 Key lock

Function: Key lock to prevent inadvertent activation.
Display after activation: key symbol.

The lock is activated for the following buttons:
"MODE, CAL, HOLD, REF"

The key lock remains active after switching the unit off and back on again!

Pressing and holding (≥ 3 sec) the "Key" button disables the key lock.

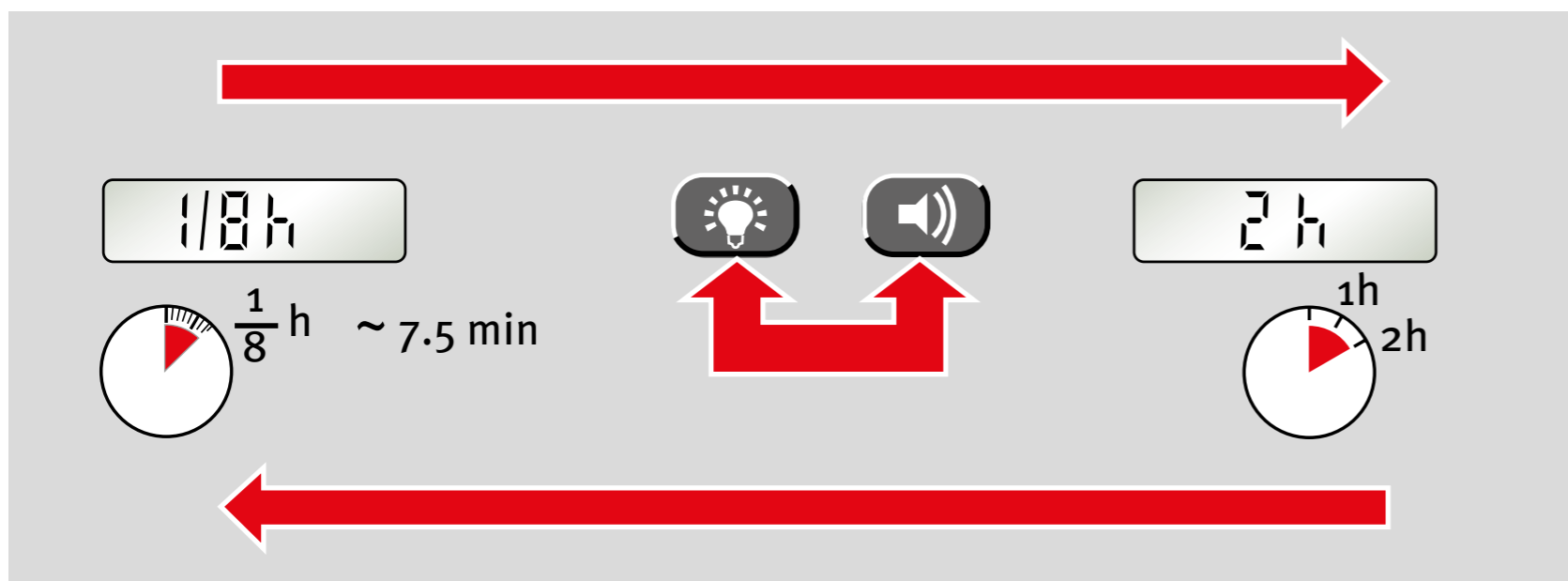

6.9 Automatic switch-off time: Auto OFF

Pressing the "Lighting" and "Acoustic guidance" buttons at the same time allows the automatic switch-off time to be changed from 1/8 of an hour (approx. 7.5 minutes) to 2 hours. The set switch-off time is retained after the unit is switched off and is displayed briefly when it is switched on again.

7. Checking the measuring tool

7.1 Accuracy check

 To prevent incorrect measurements, the accuracy must be checked at regular intervals, e.g. before you start work, or after hard knocks or major changes in temperature.

Step 1:

Place the device with the lower measuring sole on as horizontal a surface as possible (e.g. table) with the display side facing the user. Determine the measurement.

Step 2:

Turn the unit by 180° in the same position.

Step 3:

The rear of the unit is now facing the user. Compare the new measurement with the measurement determined in step 1. In the case of deviations $> 0.05^\circ$, the unit must be calibrated again (-> Calibration).

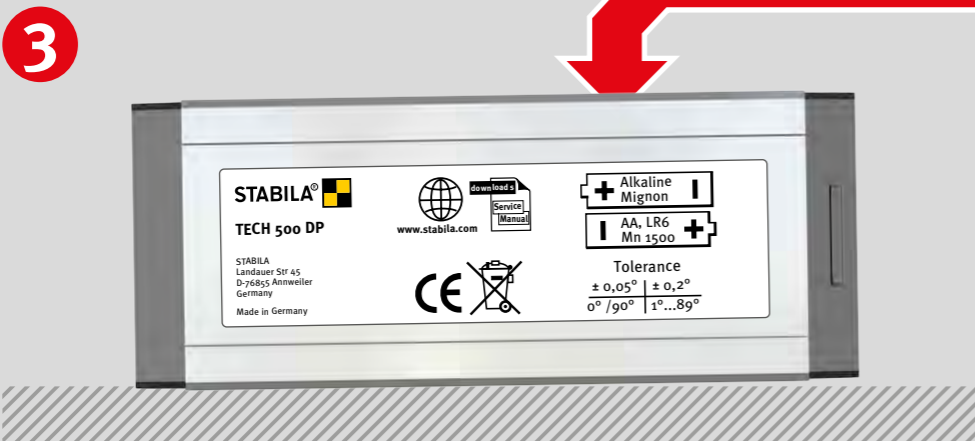
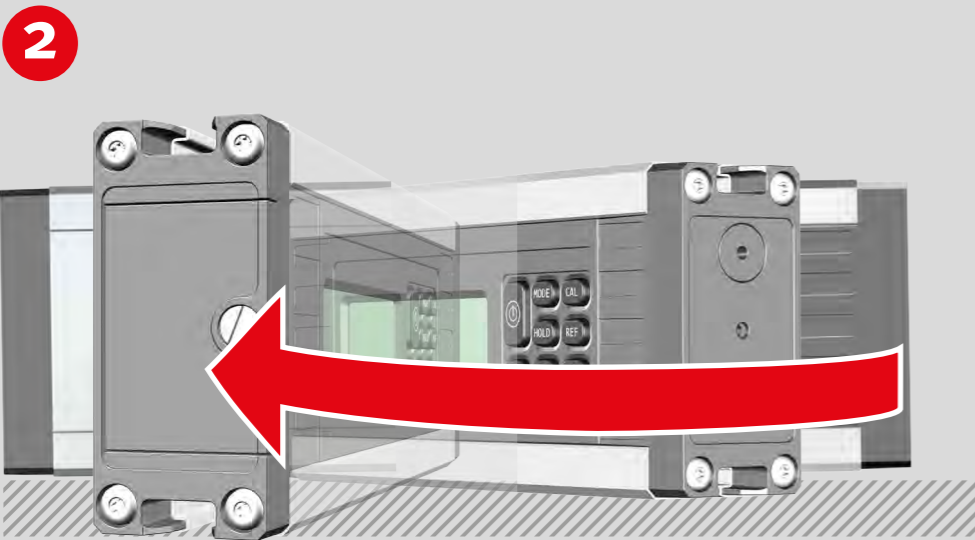

7.2 Calibration

The measuring sole calibration is activated with the "CAL" button.

-CAL- display:

Step 1:

Place the device with the lower measuring sole on as horizontal a surface as possible (e.g. table) with the display side facing the user. The first calibration is started by pressing the "CAL" button. CAL flashes in the display.

-CAL2- display:

Calibration step 1 successfully completed.

Step 2:

Turn the unit by 180° in the same position.

Step 3:

The rear of the unit is now facing the user. The second calibration is started by pressing the "CAL" button. CAL flashes in the display.

rdy display: Calibration completed successfully!

1



2

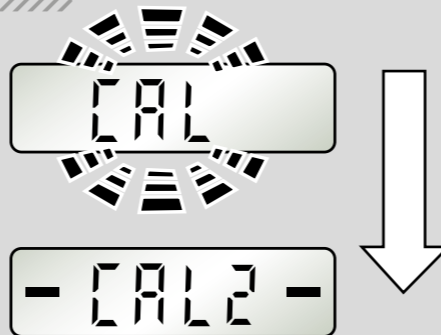
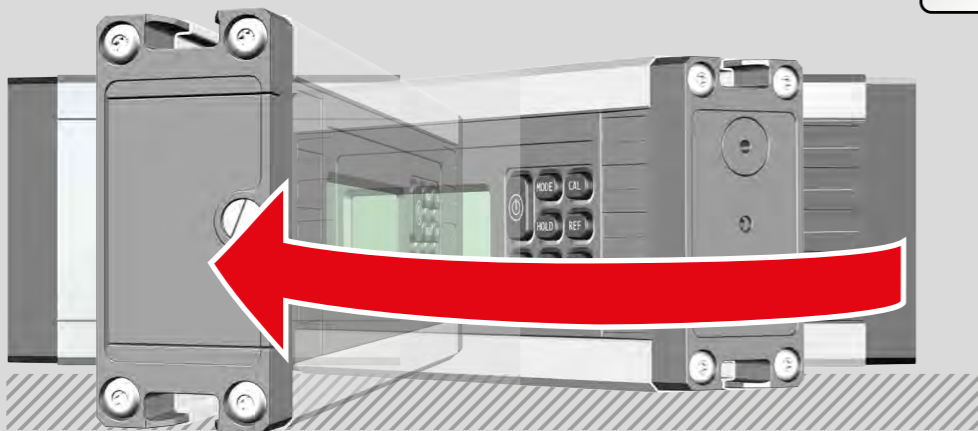

3

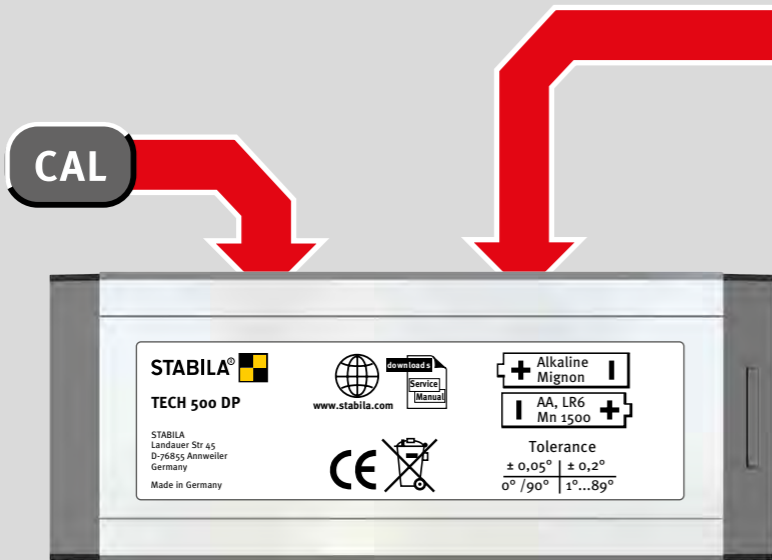



Cal.



7.3 Adjusting the sensor

The sensor must be adjusted if the temperature or Cal. symbols are shown in the display.

A:

All 4 planes are adjusted during the sensor adjustment.

B:

The sensor can only be adjusted if the two black bars appear on the display (in the range of 0° and 90°).

C:

CAL and the planes still to be adjusted flash alternately while the sensor is being adjusted for the respective plane.

D:

Planes that have not been adjusted flash in the display. Successfully adjusted planes are permanently indicated in the display.

A

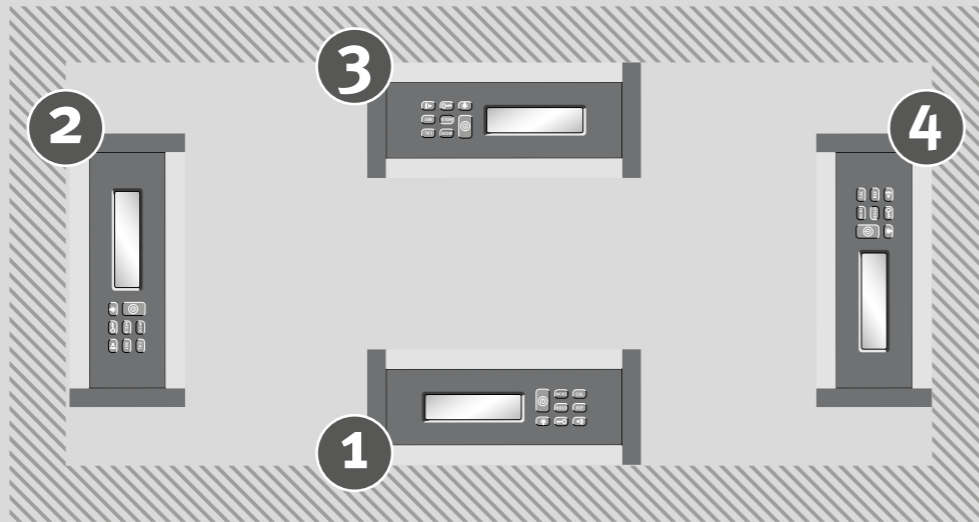

B



C

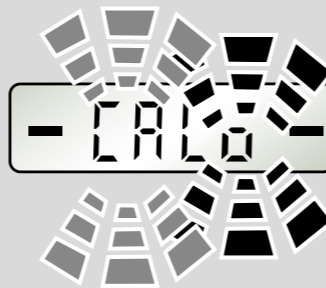

D



7.3 Adjusting the sensor

Step 1:

Simultaneously press the "MODE" and "CAL" buttons.

Step 2:

Hold the unit in plane 1.

Press the "CAL" button.

If the plane has been adjusted successfully, it is permanently indicated in the display.

1

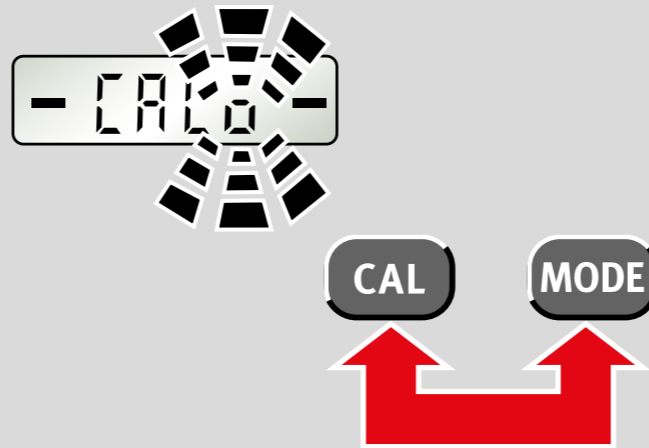

2



1

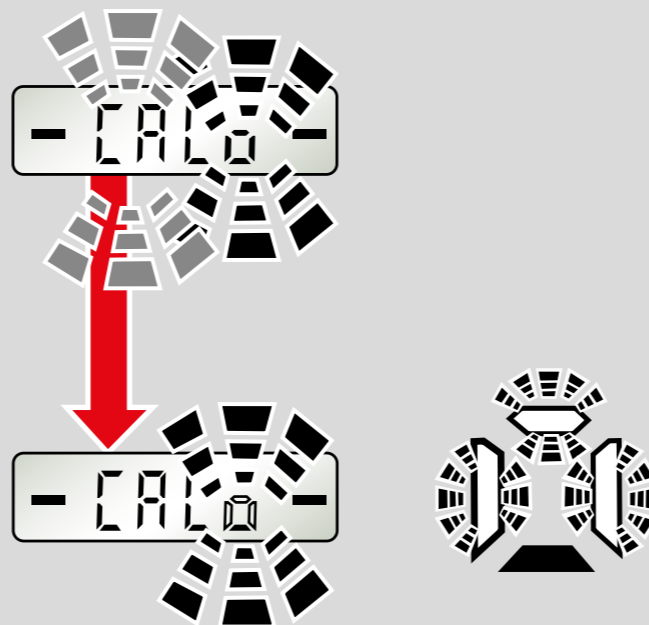

7.3 Adjusting the sensor

Step 3:

Turn the unit by 90° to plane 2.

Press the "CAL" button.

If the plane has been adjusted successfully, it is permanently indicated in the display.

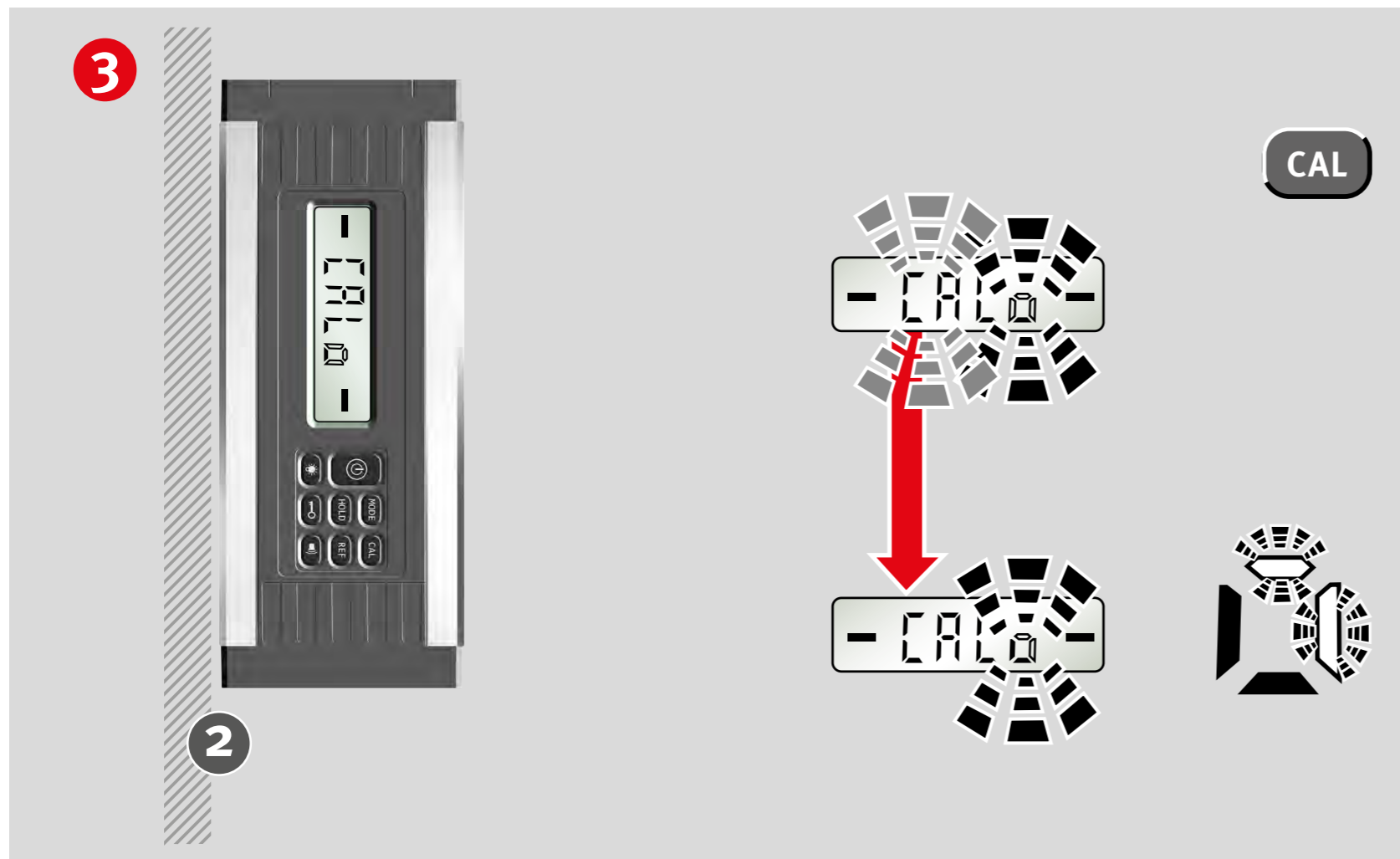

Step 4:

Turn the unit by 90° to plane 3.

Press the "CAL" button.

If the plane has been adjusted successfully, it is permanently indicated in the display.

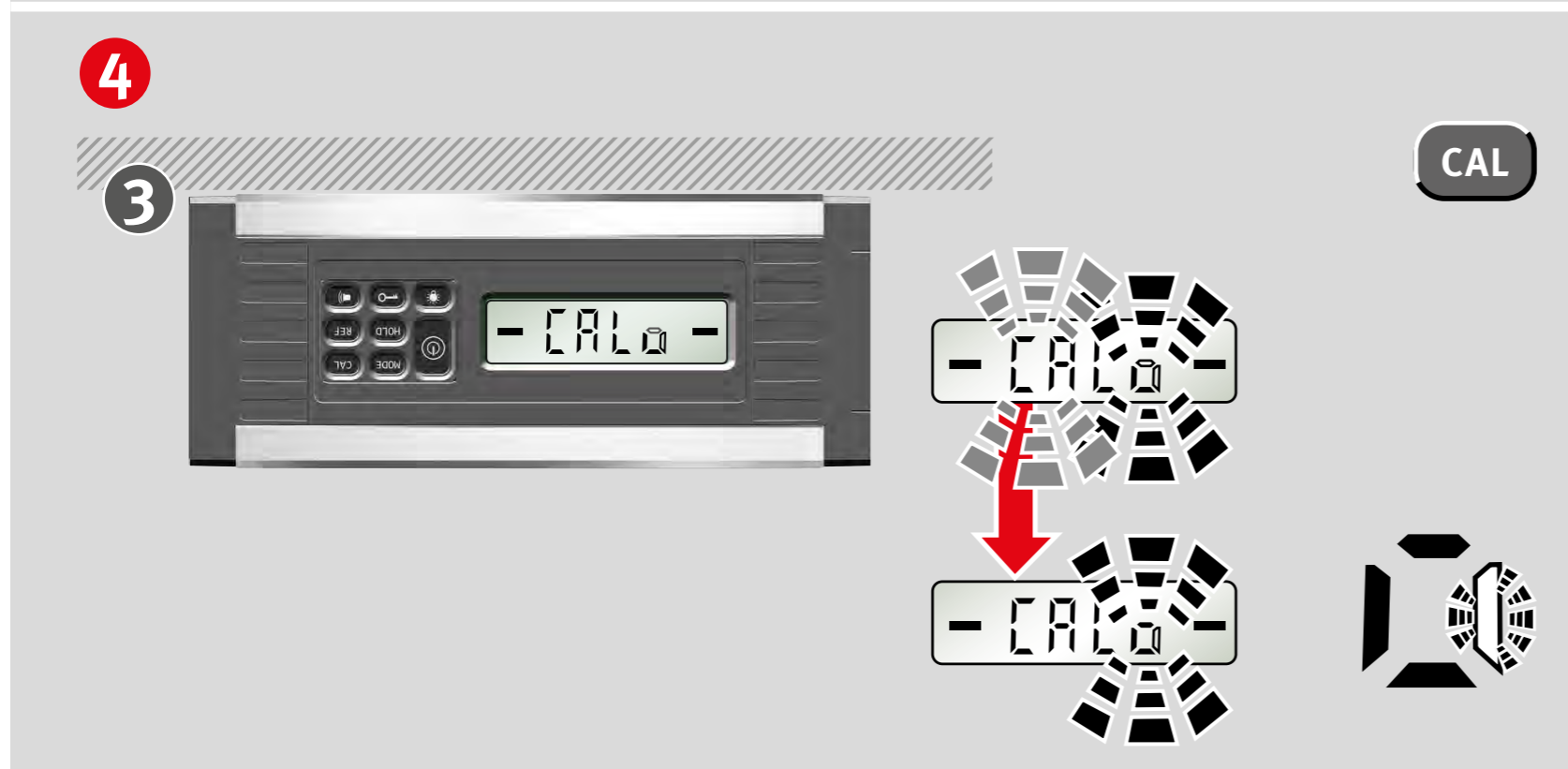

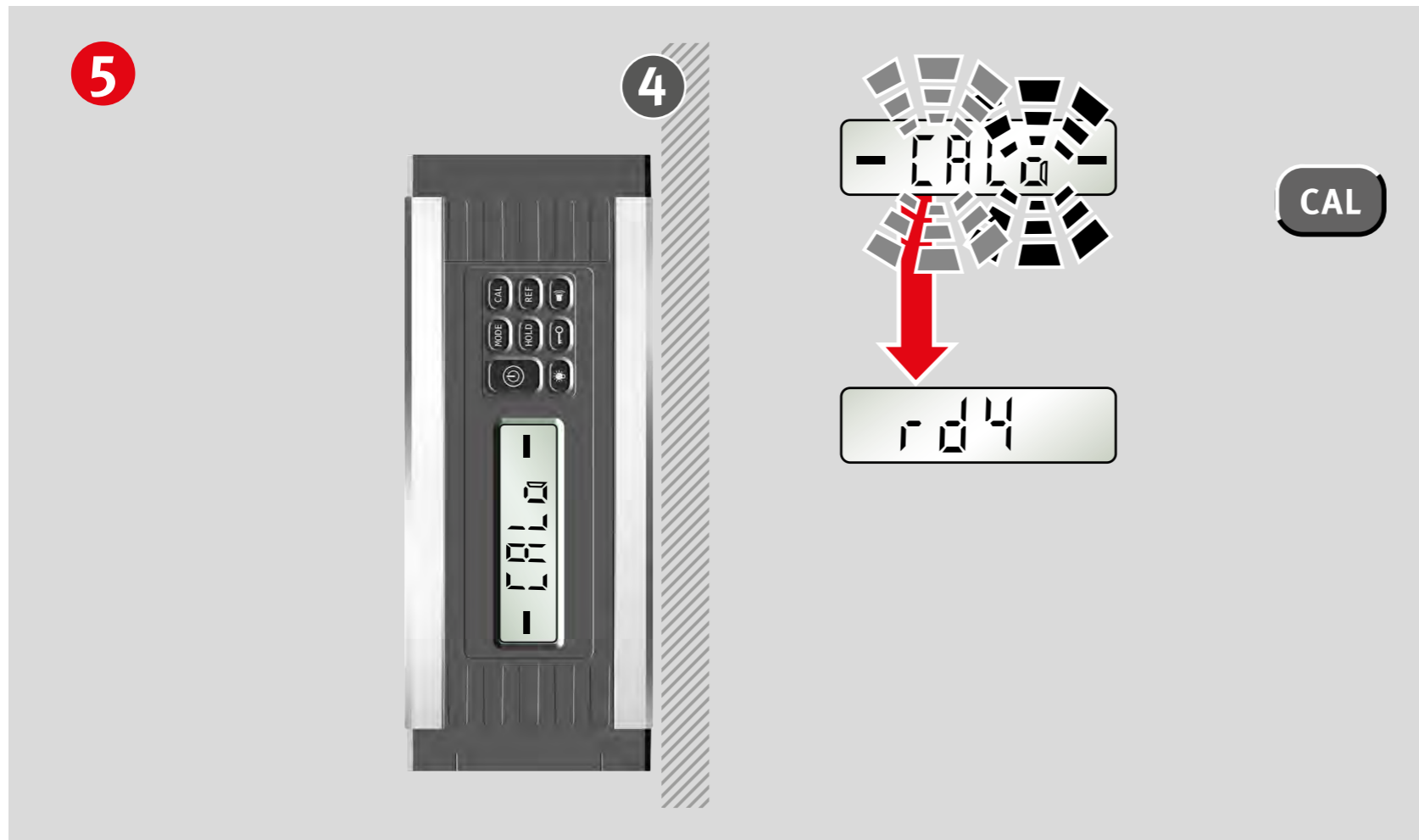

7.3 Adjusting the sensor

Step 5:

Turn the unit by 90° to plane 4.

Press the "CAL" button.

If the last plane has been adjusted successfully, "rd4" is indicated in the display.

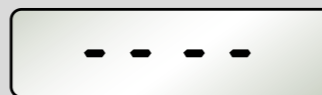
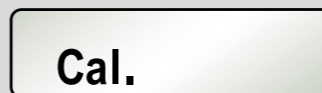

7.4 Error messages

Display: Cal. /temperature

The sensor must be adjusted if the temperature or Cal. symbols are indicated in the display.

Display: Err

The unit must not be moved or subjected to vibrations during the calibration/sensor adjustment. This can lead to measurement errors.

Display: ----

Unit inclination around longitudinal axis $> 10^\circ$

8. Technical data

Accuracy:

0° / 90° / 180° / 270° :	± 0,05°
In intermediate areas	± 0,2°

Batteries:

2 x 1,5 V alkaline,
Mignon, AA, LR6, MN1500

Battery life:

≥ 150 hours

Operating temperature range:

-10 °C to +50 °C
14 °F to 122 °F

Storage temperature range:

-20 °C to +65 °C
-4 °F to 149 °F

Housing material:

Aluminium / PC-ABS

Dimensions:

ca. 70 x 32 x 175 mm

Weight:

440 g

Protection class:

IP 65

Subject to technical modifications.

Europe
Middle and South America
Australia
Asia
Africa

CE **STABILA Messgeräte**
Gustav Ullrich GmbH

P.O. Box 13 40 / D-76851 Annweiler
Landauer Str. 45 / D-76855 Annweiler

☎ + 49 63 46 309 - 0
✉ info@stabila.de

USA
Canada

STABILA Inc.

332 Industrial Drive
South Elgin, IL 60177

☎ 800-869-7460
✉ custservice@Stabila.com